

# 3059 AND 3060

## HALL-EFFECT GEAR-TOOTH SENSORS —AC COUPLED

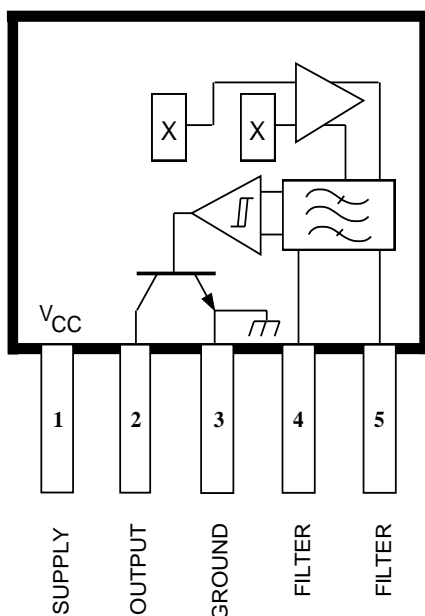

Dwg. PH-011

Pinning is shown viewed from branded side.

### ABSOLUTE MAXIMUM RATINGS at $T_A = +25^\circ\text{C}$

Supply Voltage, $V_{CC}$ .....	24 V
Reverse Battery Voltage, $V_{RCC}$ .....	-30 V
Magnetic Flux Density, $B$ .....	Unlimited
Output OFF Voltage, $V_{OUT}$ .....	24 V
Output Current, $I_{OUT}$ .....	25 mA
Package Power Dissipation, $P_D$ .....	500 mW
Operating Temperature Range, $T_A$	
Prefix 'UGN' .....	-20°C to +85°C
Prefix 'UGS' .....	-40°C to +125°C
Storage Temperature Range, $T_S$ .....	-65°C to +150°C

The UGN/UGS3059KA and UGN/UGS3060KA ac-coupled Hall-effect gear-tooth sensors are monolithic integrated circuits that switch in response to changing differential magnetic fields created by moving ferrous targets. These devices are ideal for use in non-zero-speed, gear-tooth-based speed, position, and timing applications such as in anti-lock braking systems, transmissions, and crankshafts.

Both devices, when coupled with a back-biasing magnet, can be configured to turn ON or OFF with the leading or trailing edge of a gear-tooth or slot. Changes in fields on the magnet face caused by a moving ferrous mass are sensed by two integrated Hall transducers and are differentially amplified by on-chip electronics. This differential sensing design provides immunity to radial vibration within the devices' operating air gaps. Steady-state magnet and system offsets are eliminated using an on-chip differential band-pass filter. This filter also provides relative immunity to interference from RF and electromagnetic sources. The on-chip temperature compensation and Schmitt trigger circuitry minimizes shifts in effective working air gaps and switch points over temperature, allowing operation to low frequencies over a wide range of air gaps and temperatures.

Each Hall-effect digital Integrated circuit includes a voltage regulator, two quadratic Hall-effect sensing elements, temperature compensating circuitry, a low-level amplifier, band-pass filter, Schmitt trigger, and an open-collector output driver. The on-board regulator permits operation with supply voltages of 4.5 to 24 volts. The output stage can easily switch 20 mA over the full frequency response range of the sensor and is compatible with bipolar and MOS logic circuits.

The two devices provide a choice of operating temperature ranges. Both devices are packaged in a 5-pin plastic SIP.

### FEATURES

- Senses Motion of Ferrous Targets Such as Gears
- Wide Operating Temperature Range
- Operation to 30 kHz
- Resistant to RFI, EMI
- Large Effective Air Gap
- 4.5 V to 24 V Operation
- Output Compatible With All Logic Families
- Reverse Battery Protection
- Resistant to Physical Stress

Always order by complete part number, e.g., **UGS3060KA**.

# 3059 AND 3060 HALL-EFFECT GEAR-TOOTH SENSORS —AC COUPLED

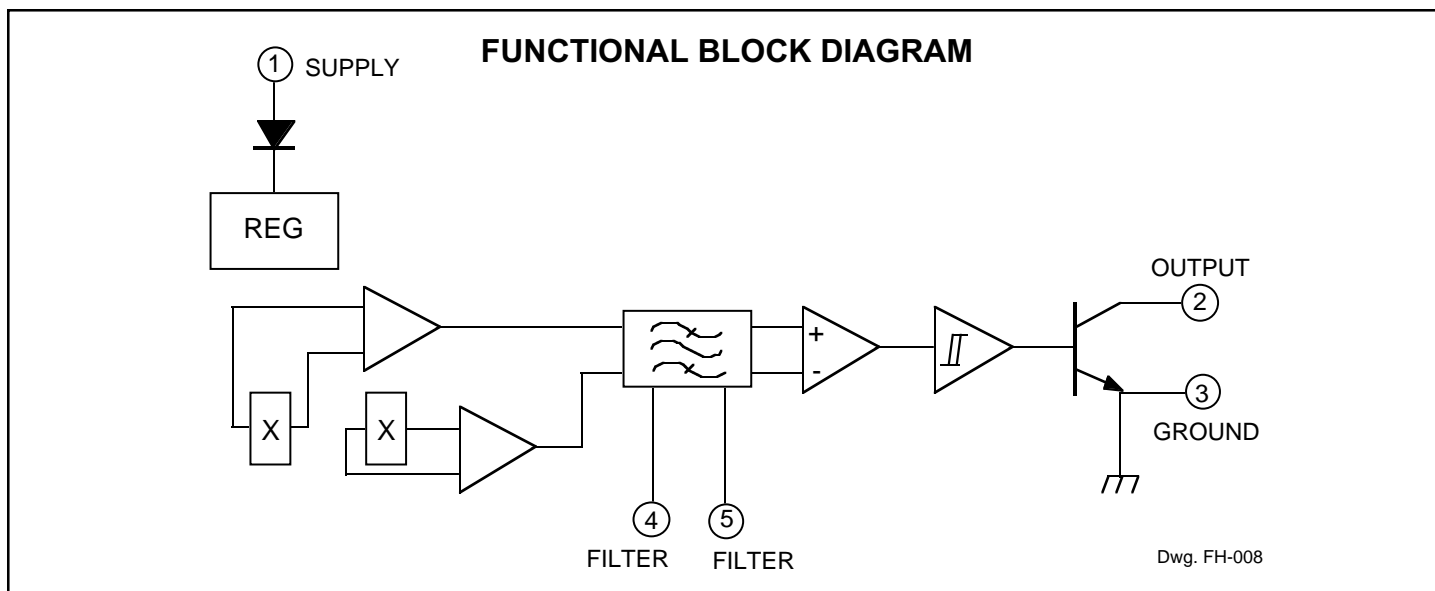

## ELECTRICAL CHARACTERISTICS over operating temperature range.

Characteristic	Symbol	Test Conditions	Limits			Units
			Min.	Typ.	Max.	
Supply Voltage	$V_{CC}$	Operating	4.5	—	24	V
Output Saturation Voltage	$V_{OUT(SAT)}$	$I_{OUT} = 20 \text{ mA}$ , $B > B_{OP}$	—	130	400	mV
Output Leakage Current	$I_{OFF}$	$V_{OUT} = 24 \text{ V}$ , $B < B_{RP}$	—	—	10	$\mu\text{A}$
Supply Current	$I_{CC}$	$V_{CC} = 18 \text{ V}$ , $B < B_{RP}$	—	11	20	mA
High-Frequency Cutoff	$f_{coh}$	-3 dB	30	—	—	kHz
Output Rise time	$t_r$	$V_{OUT} = 12 \text{ V}$ , $R_L = 820 \Omega$	—	0.04	0.2	$\mu\text{s}$
Output Fall time	$t_f$	$V_{OUT} = 12 \text{ V}$ , $R_L = 820 \Omega$	—	0.18	0.3	$\mu\text{s}$

## MAGNETIC CHARACTERISTICS over operating temperature and supply voltage ranges

Characteristic	Test Conditions	Part Numbers*						Units
		3059			3060			
		Min.	Typ.	Max.	Min.	Typ.	Max.	
Operate Point, $B_{OP}$	Output switches OFF to ON	10	65	100	5.0	15	35	G
Release Point, $B_{RP}$	Output switches ON to OFF	-100	-65	-10	-35	-15	-5.0	G
Hysteresis, $B_{hys}$	$B_{OP} - B_{RP}$	—	130	—	—	30	—	G

NOTES: \* Complete part number includes a prefix to identify operating temperature range (UGN or UGS) and the package suffix KA.

- Magnetic switch points are specified as the difference in magnetic fields at the two Hall elements.
- As used here, negative flux densities are defined as less than zero (algebraic convention).
- Typical values are at  $T_A = 25^\circ\text{C}$  and  $V_{CC} = 12 \text{ V}$ .
- 1 gauss (G) is exactly equal to 0.1 millitesla (mT).

# 3059 AND 3060 HALL-EFFECT GEAR-TOOTH SENSORS —AC COUPLED

## TYPICAL OPERATING CHARACTERISTICS

### SWITCH POINTS

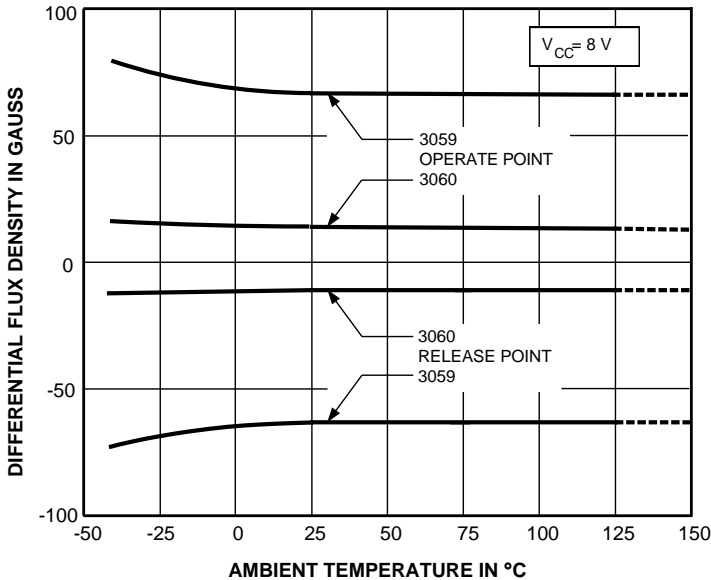

Dwg. GH-056

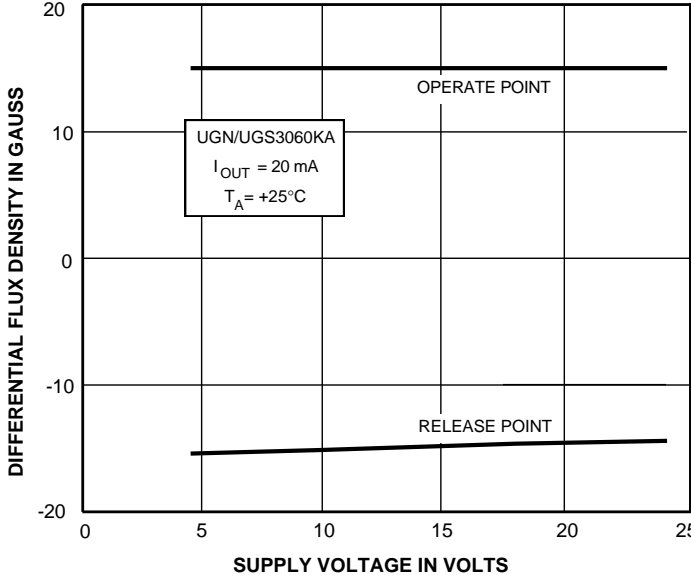

Dwg. GH-057

### OUTPUT SATURATION VOLTAGE

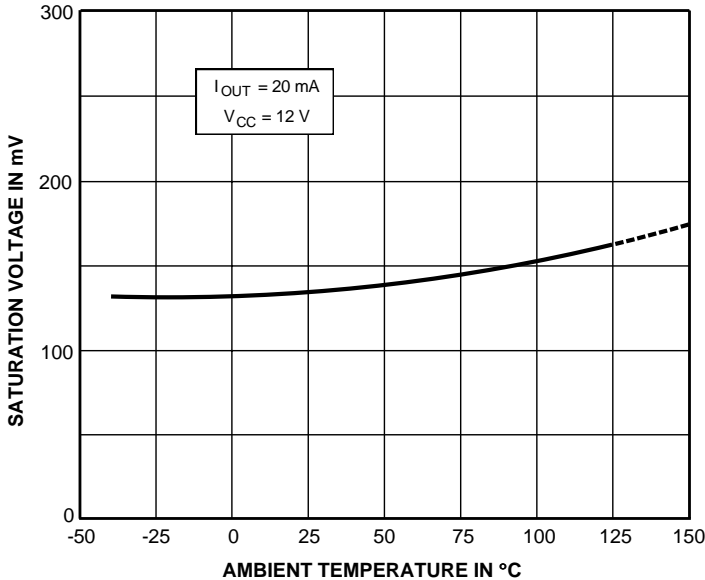

Dwg. GH-029-1

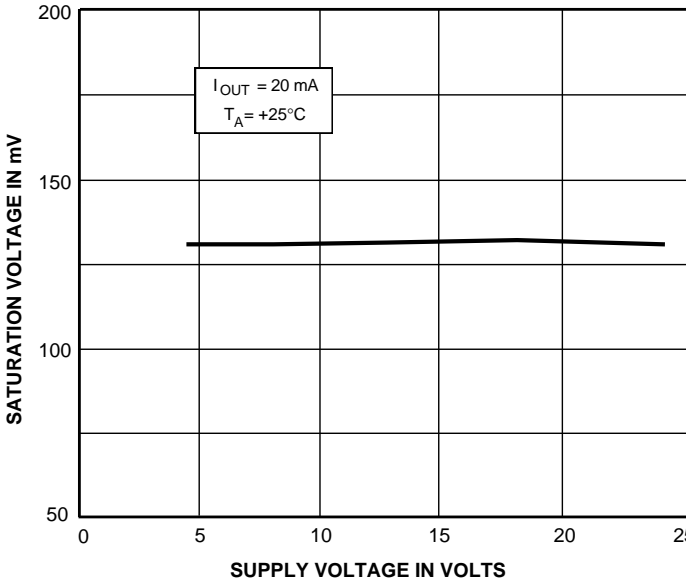

Dwg. GH-055

# 3059 AND 3060 HALL-EFFECT GEAR-TOOTH SENSORS —AC COUPLED

## TYPICAL OPERATING CHARACTERISTICS

### SUPPLY CURRENT

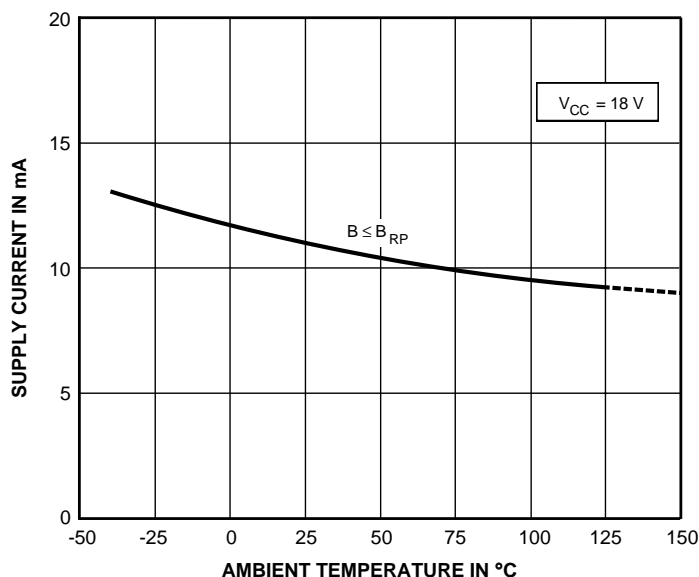

Dwg. GH-028-1

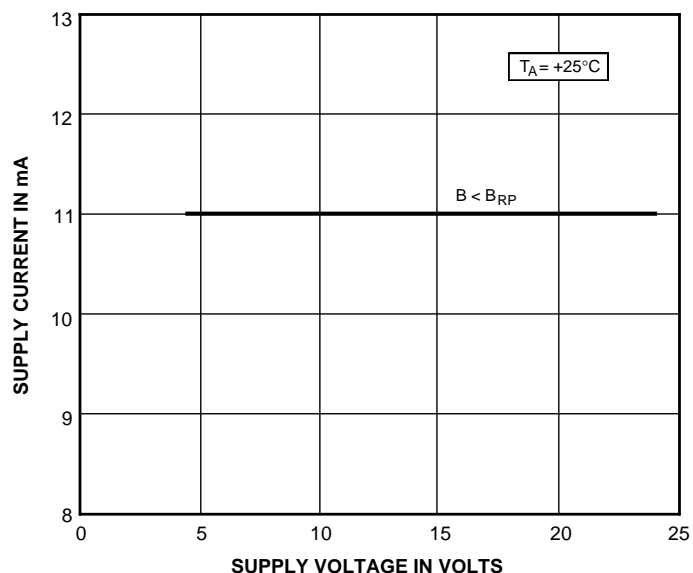

Dwg. GH-031-1

## APPLICATIONS INFORMATION

A gear-tooth sensing system consists of the sensor IC, a back-biasing magnet, and a target. The system requirements are usually specified in terms of the effective working air gap between the package and the target (gear teeth), the number of switching events per rotation of the target, temperature and speed ranges, minimum pulse duration or duty cycle, and switch point accuracy. Careful choice of the sensor IC, magnet material and shape, target material and shape, and assembly techniques enables large working air gaps and high switch-point accuracy over the system operating temperature range.

**Naming Conventions.** With a south pole in front of the branded surface of the sensor or a north pole behind the sensor, the field at the sensor is defined as positive.

As used here, negative flux densities are defined as less than zero (algebraic convention), e.g., -100 G is less than +50 G.

**Magnet Biasing.** In order to sense moving non-magnetized ferrous targets, these devices must be back-biased by mounting the unbranded side on a small permanent magnet. Either magnetic pole (north or south) can be used.

The devices can also be used without a back-biasing magnet. In this configuration, the sensor can be used to detect a rotating ring magnet such as those found in brushless dc motors or in speed sensing applications. Here, the sensor detects the magnetic field gradient created by the magnetic poles.

# 3059 AND 3060 HALL-EFFECT GEAR-TOOTH SENSORS —AC COUPLED

## APPLICATIONS INFORMATION (cont'd)

**Figure 1  
TYPICAL TRANSFER  
CHARACTERISTIC**

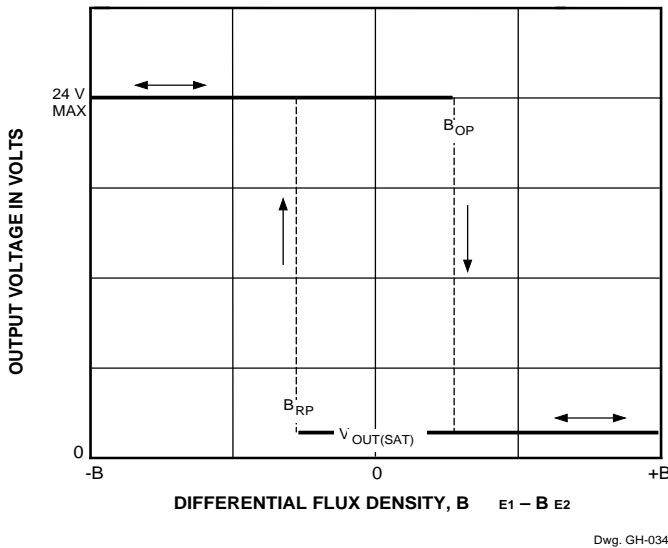

**Sensor Operation.** These sensor ICs each contain two integrated Hall transducers (E1 and E2) that are used to sense a magnetic field differential across the face of the IC (see Sensor Location drawing). Referring to Figure 1, the trigger switches the output ON (output LOW) when  $B_{E1} - B_{E2} < B_{OP}$  and switches the output OFF (output HIGH) when  $B_{E1} - B_{E2} < B_{RP}$ . The difference between  $B_{OP}$  and  $B_{RP}$  is the hysteresis of the device.

Figure 2 relates the output state of a back-biased sensor IC, with switching characteristics shown in Figure 1, to the target gear profile and position. Assume a north pole back-bias configuration (equivalent to a south pole at the face of the device). The motion of the gear produces a phase-shifted field at E1 and E2 (Figure 2(a)); internal conditioning circuitry subtracts the fields at the two elements (Figure 2(b)); this differential field is band-pass filtered to remove dc offset components and then fed into a Schmitt trigger; the Schmitt trigger switches the output transistor at the thresholds  $B_{OP}$  and  $B_{RP}$ . As shown (Figure 2(c)), the IC output is LOW whenever sensor E1 sees a (ferrous) gear tooth and sensor E2 faces air. The output is HIGH when sensor E1 sees air and sensor E2 sees the ferrous target.

**Figure 2**

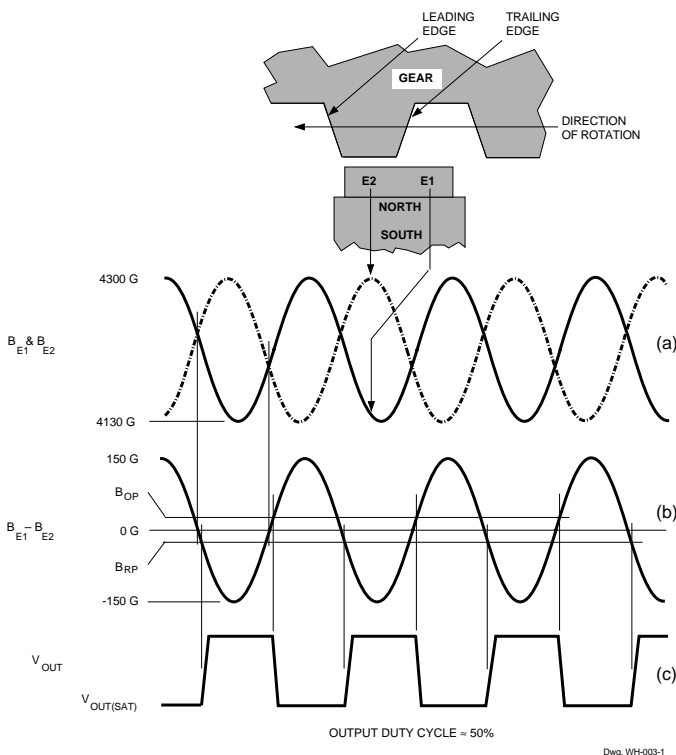

**AC-Coupled Operation.** Steady-state magnet and system offsets are eliminated using an on-chip differential band-pass filter. The lower frequency cut-off of this patented filter is set using an external capacitor the value of which can range from 0.01  $\mu\text{F}$  to 10  $\mu\text{F}$ . The high-frequency cut-off of this filter is set at 30 kHz by an internal integrated capacitor.

The differential structure of this filter enables the IC to reject single-ended noise on the ground or supply line and, hence, makes it resistant to radio-frequency and electromagnetic interference typically seen in hostile remote sensing environments. This filter configuration also increases system tolerance to capacitor degradation at high temperatures, allowing the use of an inexpensive external ceramic capacitor.

# 3059 AND 3060 HALL-EFFECT GEAR-TOOTH SENSORS —AC COUPLED

## APPLICATIONS INFORMATION (cont'd)

**Low-Frequency Operation.** Low-frequency operation of the sensor is set by the value of an external capacitor. Figure 3 provides the low-frequency cut-off (-3 dB point) of the filter as a function of capacitance value. This information should be used with care. The graph assumes a perfect sinusoidal magnetic signal input. In reality, when used with gear teeth, the teeth create transitions in the magnetic field that have a much higher frequency content than the basic rotational speed of the target. This allows the device to sense speeds much lower than those indicated by the graph for a given capacitor value.

Figure 3

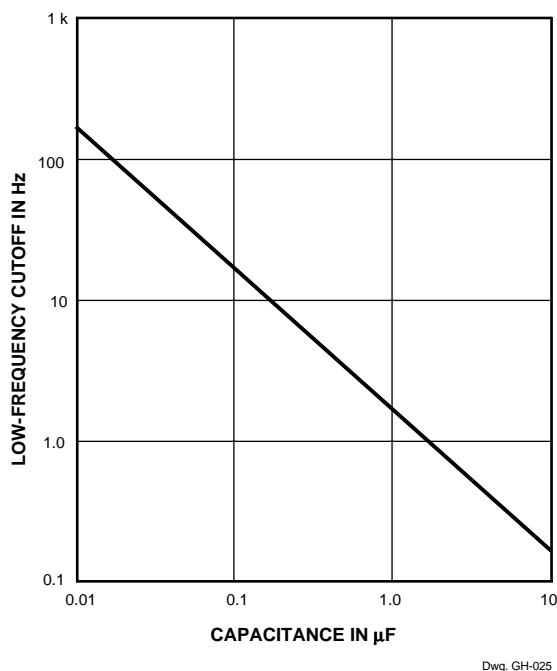

**Capacitor Characteristics.** The major requirement for the external capacitor is its ability to operate in a bipolar (non-polarized) mode. Another important requirement is the low leakage current of the capacitor (equivalent parallel resistance should be greater than 500kΩ). To maintain proper operation with frequency, capacitor values should be held to within ±30% over the operating temperature range. Available non polarized capacitors include ceramic, polyester, and some tantalum types. For low-cost operation, ceramic capacitors with temperature

codes Z5S, Y5S, X5S, or X7S (depending on operating temperature range) or better are recommended. The commonly available Z5U temperature code should not be used in this application.

**Magnet Selection.** The UGx3059KA or UGx3060KA can be used with a wide variety of commercially available permanent magnets. The selection of the magnet depends on the operational and environmental requirements of the sensing system. For systems that require high accuracy and large working air gaps or an extended temperature range, the usual magnet material of choice is rare-earth samarium cobalt (SmCo). This magnet material has a high energy product and can operate over an extended temperature range. For systems that require low-cost solutions for an extended temperature range, AlNiCo 8 can be used. Due to its relatively low energy product, smaller operational air gaps can be expected. Neodymium iron boron (NeFeB) can be used over moderate temperature ranges when large working air gaps are required. Of these three magnet materials, AlNiCo 8 is the least expensive by volume and SmCo is the most expensive.

**System Issues.** Optimal performance of a gear-tooth sensing system strongly depends on four factors: the IC magnetic parameters, the magnet, the pole piece configuration, and the target.

**Sensor Specifications.** Shown in Figure 4 are graphs of the differential field as a function of air gap. A 48-tooth, 2.5" (63.5 mm) diameter, uniform target similar to that used in ABS applications is used. The samarium cobalt magnet is 0.32" diameter by 0.20" long (8.13 x 5.08 mm). The maximum functioning air gap with this typical gear/magnet combination can be determined using the graphs and specifications for the sensor IC.

In this case, if a UGx3060KA sensor with a typical  $B_{OP}$  of 15 G and a  $B_{RP}$  of -15 G is used, the maximum allowable air gap would be approximately 0.120". If the worst case switch points of ±35 G for the UGx3060KA are used, the maximum air gap is approximately 0.105".

All system issues should be translated back to such a profile to aid the prediction of system performance.

**3059 AND 3060  
HALL-EFFECT  
GEAR-TOOTH SENSORS  
—AC COUPLED**

**APPLICATIONS INFORMATION (cont'd)**

**Figure 4  
DIFFERENTIAL FLUX DENSITY**

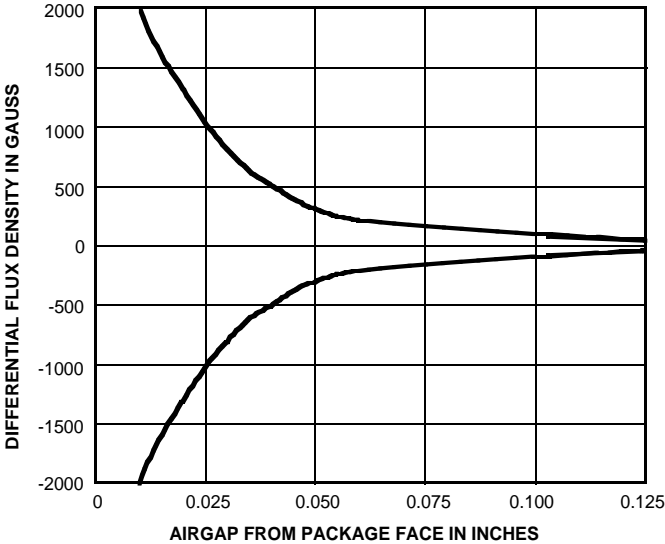

Dwg. GH-035

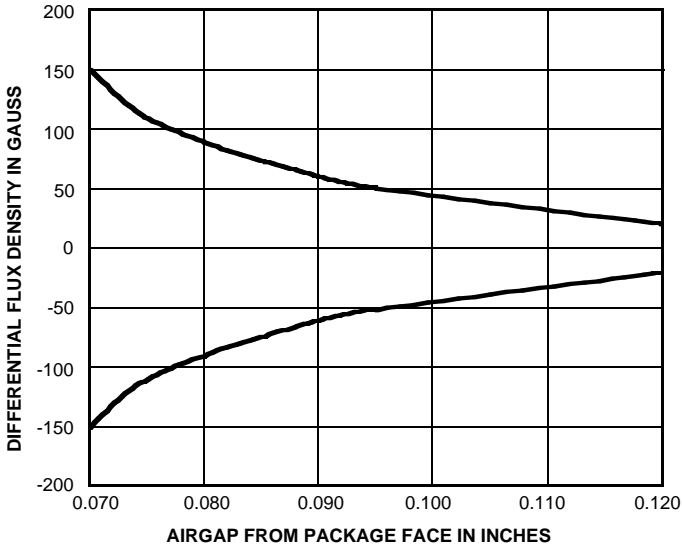

Dwg. GH-036

**Ferrous Targets.** The best ferrous targets are made of cold-rolled low-carbon steel. Sintered-metal targets are also usable, but care must be taken to ensure uniform material composition and density.

The teeth or slots of the target should be cut with a slight angle so as to minimize the abruptness of transition from metal to air as the target passes by the sensor. Sharp transitions will result in magnetic overshoots that can result in false triggering.

Gear teeth larger than 0.10" (2.54 mm) wide and at least 0.10" (2.54 mm) deep provide reasonable working air gaps and adequate change in magnetic field for reliable switching. Generally, larger teeth and slots allow a larger air gap. A gear tooth width approximating the spacing between sensors (0.088" or 2.24 mm) requires special care in the system design and assembly techniques.

**Figure 5  
SENSOR LOCATIONS  
(±0.005" [0.13 mm] die placement)**

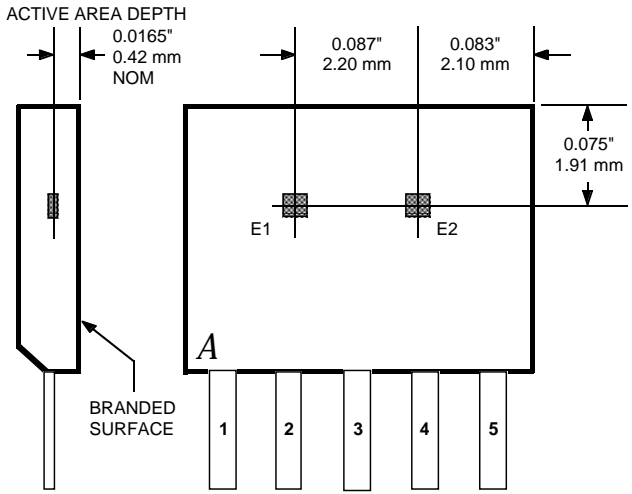

Dwg. MH-007E

# **3059 AND 3060 HALL-EFFECT GEAR-TOOTH SENSORS —AC COUPLED**

## **APPLICATIONS INFORMATION (cont'd)**

Extensive applications information for Hall-effect sensors is available in:

- *Hall-Effect IC Applications Guide*, Application Note 27701;
- *Hall-Effect Devices: Soldering, Gluing, Potting, Encapsulating, and Lead Forming*, Application Note 27703.1;
- *Soldering of Through-Hole Hall-Sensor Devices*, Application Note 27703; and
- *Soldering of Surface-Mount Hall-Sensor Devices*, Application Note 27703.2.

All are provided in *Allegro Electronic Data Book*, AMS-702. or at

[www.allegromicro.com](http://www.allegromicro.com)

*The products described herein are manufactured under one or more of the following U.S. patents: 5,045,920; 5,264,783; 5,442,283; 5,389,889; 5,581,179; 5,517,112; 5,619,137; 5,621,319; 5,650,719; 5,686,894; 5,694,038; 5,729,130; 5,917,320; and other patents pending.*

*Allegro MicroSystems, Inc. reserves the right to make, from time to time, such departures from the detail specifications as may be required to permit improvements in the performance, reliability, or manufacturability of its products. Before placing an order, the user is cautioned to verify that the information being relied upon is current.*

*Allegro products are not authorized for use as critical components in life-support appliances, devices, or systems without express written approval.*

*The information included herein is believed to be accurate and reliable. However, Allegro MicroSystems, Inc. assumes no responsibility for its use; nor for any infringements of patents or other rights of third parties that may result from its use.*



# 3059 AND 3060 HALL-EFFECT GEAR-TOOTH SENSORS —AC COUPLED

## Dimensions in Inches (controlling dimensions)

## Dimensions in Millimeters (for reference only)

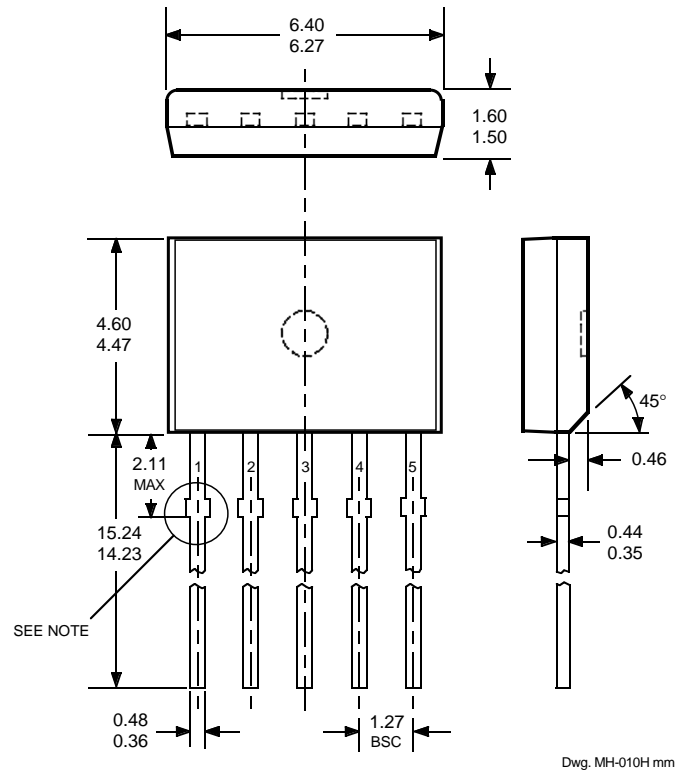
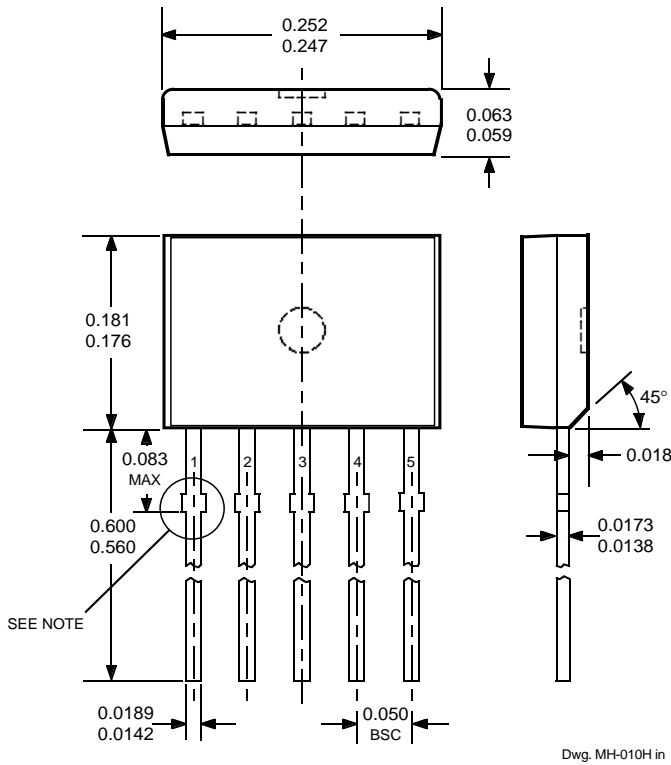

## Surface-Mount Lead Form (Suffix -TL)

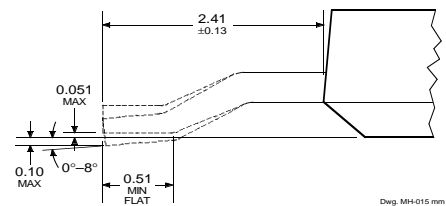
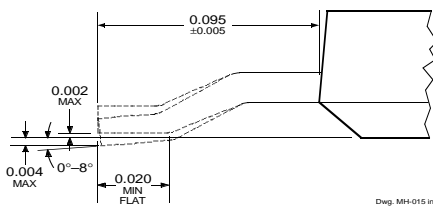

- NOTES: 1. Tolerances on package height and width represent allowable mold offsets. Dimensions given are measured at the widest point (parting line).
2. Exact body and lead configuration at vendor's option within limits shown.
3. Height does not include mold gate flash.
4. Recommended minimum PWB hole diameter to clear transition area is 0.035" (0.89 mm).
5. Where no tolerance is specified, dimension is nominal.
6. Supplied in bulk pack (500 pieces per bag).

**3059 AND 3060**  
**HALL-EFFECT**  
**GEAR-TOOTH SENSORS**  
**—AC COUPLED**

***SPECIAL-PURPOSE HALL-EFFECT SENSORS***

DUAL-OUTPUT HALL-EFFECT DIGITAL SWITCHES							
Partial Part Number	Operate Point (G) Over Oper. Voltage	Release Point (G) & Temp. Range	Hysteresis (G) Range	Oper. Temp.	Package	Comments	
UGN3235	35 to 200	15 to 190	15 to 110	S	K	independent switch outputs	
UGN3275	-200 to -35	-190 to -15	15 to 110	S	K	complementary latch outputs	
	15 to 250	-250 to -15	>100				
DIRECTION-DETECTING HALL-EFFECT DIGITAL SWITCHES							
Partial Part Number	Operate Point (G) Over Oper. Voltage	Release Point (G) & Temp. Range	Hysteresis (G) Range	Oper. Temp.	Package	Comments	
A3422x	<85	>-85	>10	E, L	KA	direction and speed outputs	
A3425L	<30	>-30	5 to 35	L	K	requires external logic	
GEAR-TOOTH/RING MAGNET (DUAL ELEMENT) HALL-EFFECT SENSORS							
See also, Adaptive Threshold Sensors (subassemblies containing sensor and magnet)							
Partial Part Number	Operate Point (G) Over Oper. Voltage	Release Point (G) & Temp. Range	Hysteresis (G) Range	Change in Trip Point (G)	Oper. Temp.	Package	Comments
A3056x	<150	>-150	15 to 90	<±75	E, L	U	zero-speed
A3058x	<250	>-250	150 to 250	<±50	E, L	U	zero-speed
UGx3059	10 to 100	-100 to -10	Typ 130	—	S, K	KA	>0.2 Hz
UGx3060	5 to 35	-35 to -5	Typ 30	—	S, K	KA	>0.2 Hz
A3064L	0 to 27.5	-12.5 to 7.5	5 to 35	—	L	KA	>0.2 Hz

Notes: 1) Typical data is at  $T_A = +25^\circ\text{C}$  and nominal operating voltage.

2) "x" = Operating Temperature Range [suffix letter or (prefix)]: S (UGN) =  $-20^\circ\text{C}$  to  $+85^\circ\text{C}$ , E =  $-40^\circ\text{C}$  to  $+85^\circ\text{C}$ , J =  $-40^\circ\text{C}$  to  $+115^\circ\text{C}$ , K (UGS) =  $-40^\circ\text{C}$  to  $+125^\circ\text{C}$ , L (UGL) =  $-40^\circ\text{C}$  to  $+150^\circ\text{C}$ .